

New Dimensions
in Motion

SPECIFICATIONS

 **HITACHI**

KH125-3

HYDRAULIC CRAWLER CRANE

Max. Lifting Capacity: 35 000kg

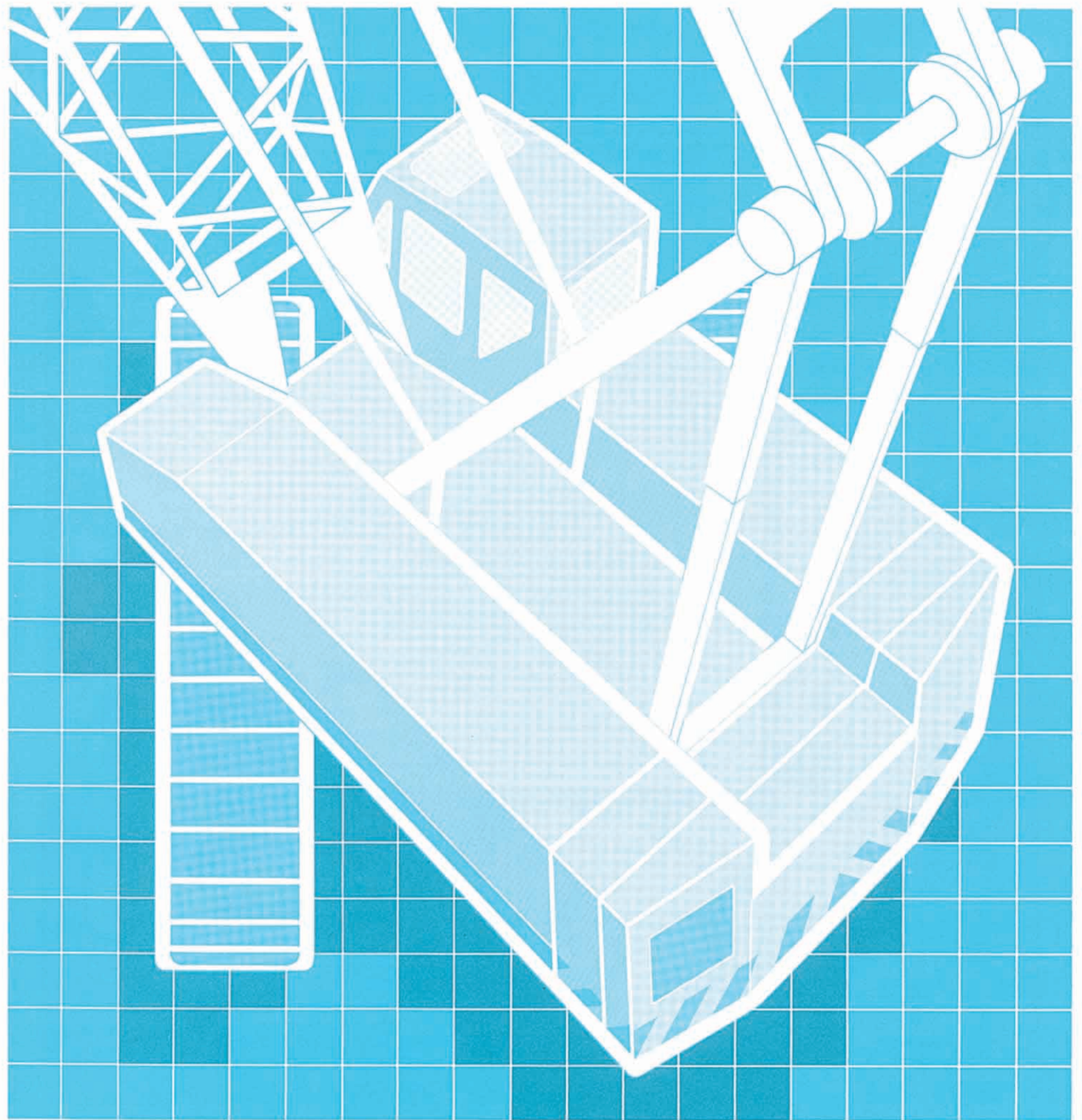

Copyright © 2000 Hitachi Construction Machinery Co., Ltd.

Front Attachments

Basic Machine

STD Basic machine

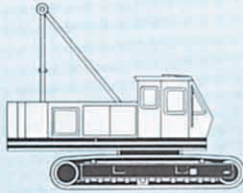

Dragline Machine

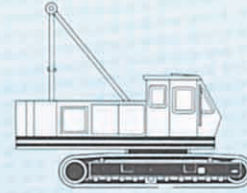

Boom

Tubular chord boom

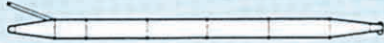

Lift crane	10 — 40 m (32'10" — 131'3")
Clamshell	10 — 19 m (32'10" — 62'4")
Pile driver	10 — 19 m (32'10" — 62'4")
Earth drill	22 m (72'2")

Angle chord boom

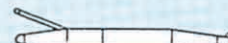

Dragline	10 — 19 m (32'10" — 62'4")
----------------	----------------------------

Attachment

Boom support type pile driver

Leader type:

45S

16 — 25 m (52'6" — 82'0")

Hammer type:

25 — 45 class

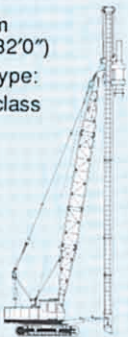

Clamshell bucket



0.6 — 1.2 m³
(0.78 — 1.57 cu yd)

Tagline Hydraulic type

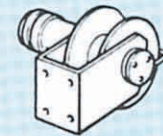

Max. digging depth:
36 m (118'1")

Dragline bucket

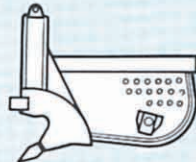

0.8 — 1.0 m³
(1.05 — 1.31 cu yd)

Fair-lead

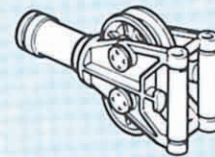

Earth drill

Max. drilling bore:

1 700 mm

Max. drilling depth:

55 m

65 m (with stem rod)



Hook blocks

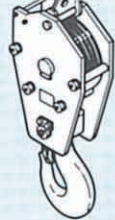

15-metric ton hook | 35-metric ton hook

Auxiliary jib

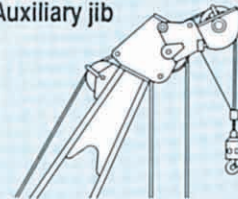

Jib

6.10 — 15.25 m (20' — 50')



5-metric ton hook

Power Transmission Mechanism and Hydraulic System

- 1 Engine
- 2 Variable displacement pump
- 3 Fixed displacement pump
- 4 Control valve
- 5 Brake valve
- 6 Counterbalance valve
- 7 Fixed displacement motor
- 8 Main hoist drum
- 9 Aux. hoist drum
- 10 Boom hoist drum
- 11 Swing mechanism
- 12 Swing circle
- 13 Center joint
- 14 Travel mechanism
- 15 Drive tumbler
- 16 Oil cooler
- 17 Filter
- 18 Hydraulic tank
- 19 Operator's cab

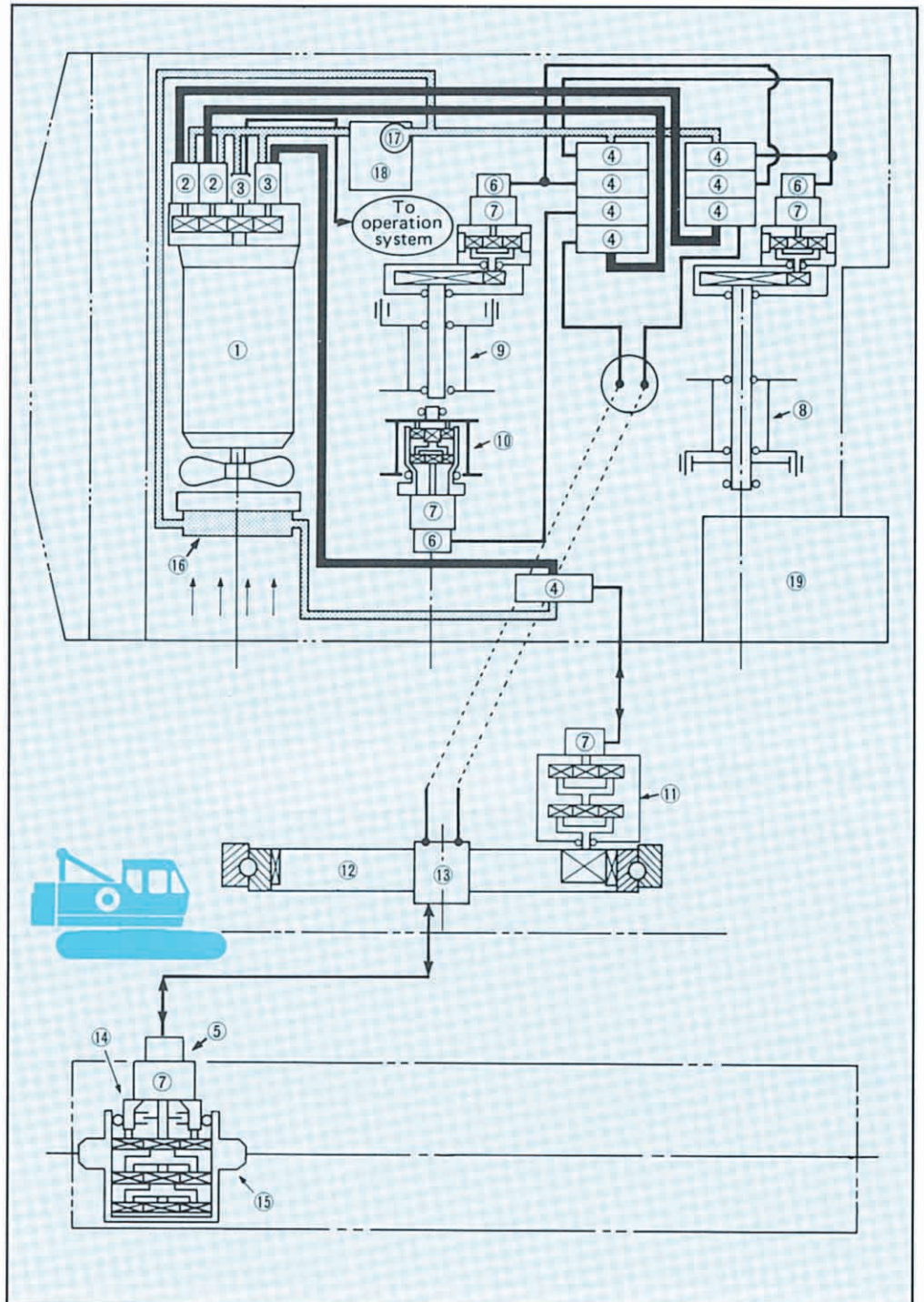

Dimensions

Unit: mm (ft in)

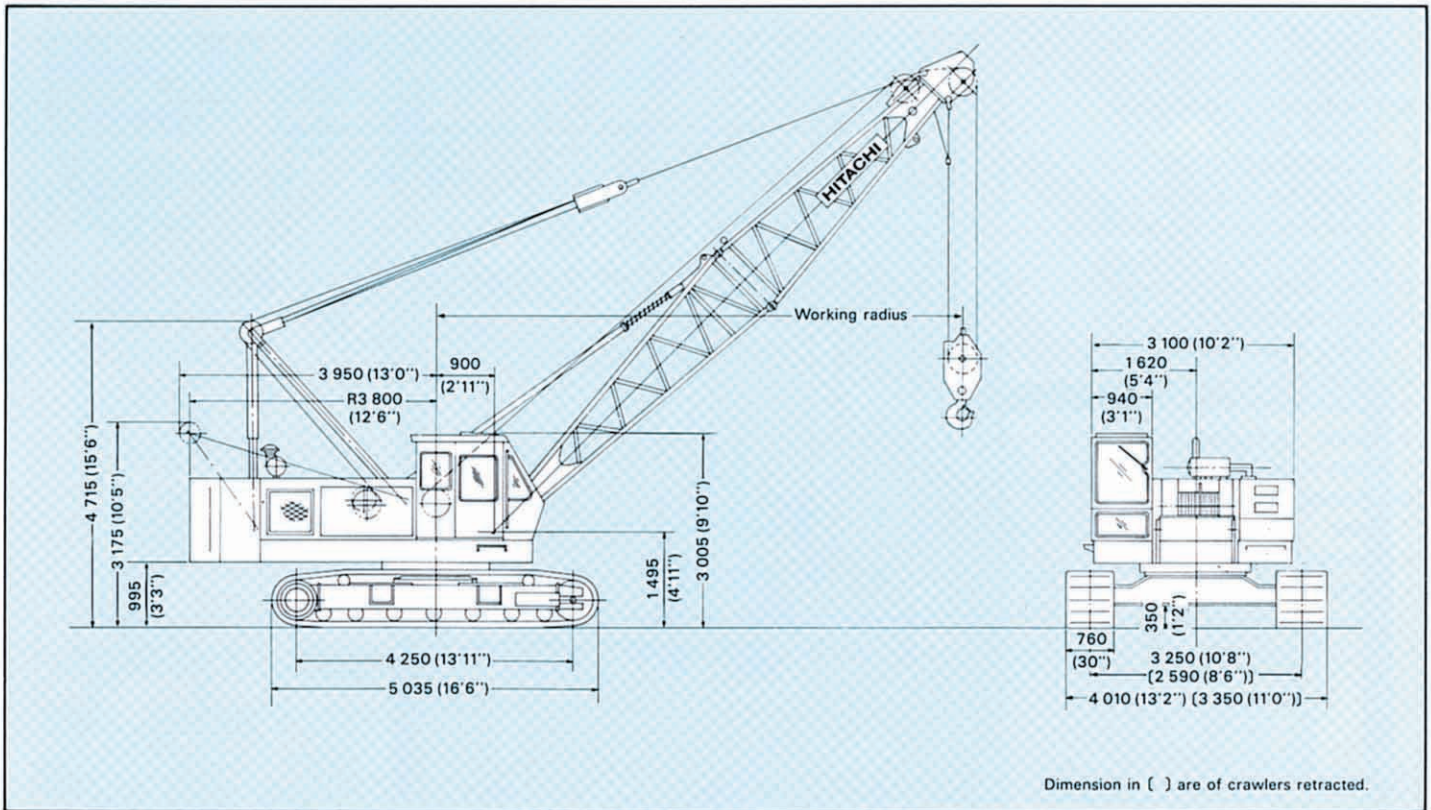

Specifications

Maximum rated load		35 000 kg (77 200 lb) at 3.6 m (11'10") working radius
Boom length	Basic boom	10.0 m (32'10")
	Max. boom	40.0 m (131'3")
	Jib	6.10 m (20'0") — 9.15 m (30'0") — 12.20 m (40'0") — 15.25 m (50'0")
	Max. boom with jib	46.2 m (151'7") [34.0 m (111'7") + 12.2 m (40'0")]
Swing speed		0 — 4.0 min ⁻¹ (0 — 4.0 rpm)
Travel speed		0 — 1.8 km/h (0 — 1.12 mph)
Gradeability		22° (40%)
Operating weight	Equipped with basic boom, 35 000 kg (77 200 lb) capacity hook and 11 600 kg (25 600 lb) counterweight	Approx. 36 600 kg (80 700 lb)
Ground pressure		0.53 bar (0.53 kgf/cm ² , 7.54 psi)
Engine	Model	HINO H06C-T
	Rated horsepower	110 kW (150 PS) at 2 000 min ⁻¹ (2 000 rpm)

HOOKS

Capacity	Self weight	Number of hoist reeving and maximum rated loads							
		7	6	5	4	3	2	1	
35 000 kg (77 200 lb)	390 kg (860 lb)	35 000 kg (77 200 lb)	34 200 kg (75 400 lb)	28 500 kg (62 800 lb)	22 800 kg (50 300 lb)	17 100 kg (37 700 lb)	11 400 kg (25 100 lb)		Standard for main boom
15 000 kg (33 100 lb)	300 kg (660 lb)					15 000 kg (33 100 lb)	11 400 kg (25 100 lb)		Optional for main boom
5 000 kg (11 000 lb)	130 kg (287 lb)							5 000 kg (11 000 lb)	Optional for jib or aux. jib

DRUMS

Dimensions

	Rope dia.	Width	Drum p.c.d.	Max. rope capacity
Main hoist drum	20 mm (0.787")	306 mm (12.05")	420 mm (16.54")	220 mm (722')
Aux. hoist drum	20 mm (0.787")	306 mm (12.05")	420 mm (16.54")	220 mm (722')

Line speed and line pull

H : High speed range L : Low speed range

	Max. line speed m/min (ft/min)				Effective line pull	@	Line speed	Max. starting line pull	Max. running line pull
	Hoisting		Lowering						
Main hoist drum	H	70 (230)	H	70 (230)	108 kN (11 000 kgf, 24 300 lbf)	@	34 m/min (112 ft/min)	137 kN (14 000 kgf, 30 900 lbf)	143 kN (14 600 kgf, 32 000 lbf)
	L	35 (115)	L	35 (115)					
Aux. hoist drum	H	70 (230)	H	70 (230)	108 kN (11 000 kgf, 24 300 lbf)	@	34 m/min (112 ft/min)	137 kN (14 000 kgf, 30 900 lbf)	143 kN (14 600 kgf, 32 000 lbf)
	L	35 (115)	L	35 (115)					

Notes:

- Line speed and line pull are based on first layer of winding at rated engine rpm.
- Hoisting line speed varies with load.
- Line pull is based on a single line pull in high speed range.
- Effective line pull is equivalent to available line pull of mechanical drive winch.
- When starting, hydraulic motor is without rotating, the line pull is "Max. starting line pull". After motor rotating, the line pull becomes "Max. running line pull" shortly.

BOOM HOIST DRUM

Rope diameter	Hoisting line speed	Lowering line speed
14 mm (0.551")	60 m/min (197 ft/min)	60 m/min (197 ft/min)

Working Ranges

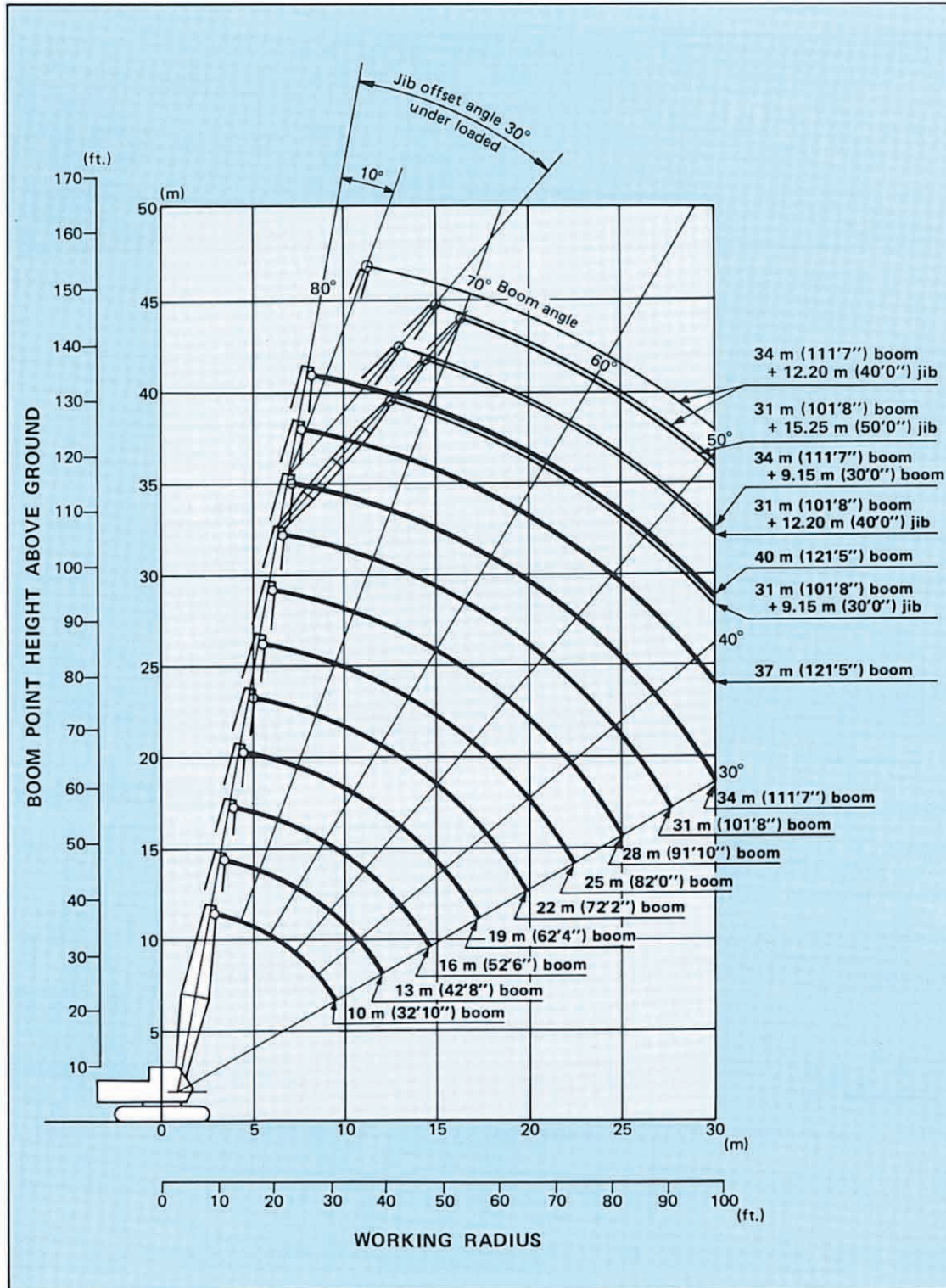

Hook Clearance

Boom

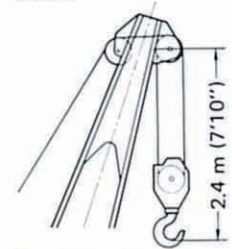

35 000 kg (77 200 lb)
Capacity hook

Jib

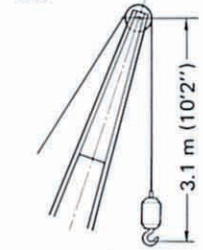

5 000 kg (11 000 lb)
Capacity hook

Crane Ratings

JIS Rating:

The rated loads shown don't exceed 78% of tipping loads with the machine on firm level ground.

BS Rating:

The rated loads are determined according to BS (British Standard; 1981) on condition that the machine is stationed on firm, level ground.

PCSA Rating:

The rated loads listed are determined according to PCSA (Power Crane and Shovel Association is U.S.A.) and do not exceed 75% of tipping load on condition that the machine is stationed on firm, level ground.

Tubular Chord Crane Boom in 360° Working Area with Fully Extended Side Frames

Boom length	Working radius		Boom angle	Boom point height		Rated load				
						JIS rating	BS rating		PCSA rating	
m (ft in)	m	ft in	degree	m	ft in	kg	kg	lb	kg	lb
10.0 (32'10")	3.0	9'10"	79.26	11.3	37'1"	35 000	35 000	77 100	35 000	77 100
	3.5	11'6"	76.31	11.2	36'9"	35 000	35 000	77 100	35 000	77 100
	3.6	11'10"	75.71	11.1	36'5"	35 000	35 000	77 100	33 650	74 100
	3.7	12'2"	75.12	11.1	36'5"	33 450	33 450	73 700	32 100	70 700
	4.0	13'1"	73.32	11.0	36'1"	29 350	29 350	64 700	28 150	62 000
	4.5	14'9"	70.28	10.8	35'5"	24 300	24 300	53 500	23 350	51 400
	5.0	16'5"	67.18	10.6	34'9"	20 750	20 750	45 700	19 900	43 800
	6.0	19'8"	60.72	10.1	33'2"	15 950	15 950	35 100	15 300	33 700
	7.0	23'0"	53.80	9.4	30'10"	12 950	12 950	28 500	12 400	27 300
	8.0	26'3"	46.16	8.6	28'3"	10 850	10 850	23 900	10 350	22 800
9.0	29'6"	37.30	7.4	24'3"	9 300	9 300	20 500	8 900	19 600	
9.6	31'6"	30.95	6.4	21'0"	8 500	8 500	18 700	8 100	17 800	
13.0 (42'8")	3.6	11'10"	79.07	14.2	46'7"	35 000	35 000	77 100	33 600	74 000
	3.7	12'2"	78.62	14.2	46'7"	33 350	33 350	73 500	32 050	70 600
	4.0	13'1"	77.26	14.1	46'3"	29 250	29 250	64 400	28 100	61 900
	4.5	14'9"	74.98	14.0	45'11"	24 250	24 250	53 400	23 250	51 200
	5.0	16'5"	72.68	13.8	45'3"	20 650	20 650	45 500	19 800	43 600
	6.0	19'8"	67.96	13.5	44'4"	15 900	15 900	35 000	15 200	33 500
	7.0	23'0"	63.08	13.0	42'8"	12 850	12 850	28 300	12 300	27 100
	8.0	26'3"	57.96	12.4	40'8"	10 750	10 750	23 600	10 250	22 500
	9.0	29'6"	52.52	11.7	38'5"	9 200	9 200	20 200	8 800	19 400
	10.0	32'10"	46.64	10.8	35'5"	8 050	8 050	17 700	7 650	16 800
12.0	39'4"	32.44	8.3	27'3"	6 350	6 350	13 900	6 050	13 300	
12.2	40'0"	30.71	7.9	25'11"	6 200	6 200	13 600	5 900	13 000	
16.0 (52'6")	4.1	13'5"	79.30	17.2	56'5"	28 000	29 200	64 300	28 050	61 800
	4.5	14'9"	77.86	17.1	56'1"	24 200	24 200	53 300	23 200	51 100
	5.0	16'5"	76.01	17.0	55'9"	20 600	20 600	45 400	19 750	43 500
	6.0	19'8"	72.27	16.7	54'10"	15 800	15 800	34 800	15 150	33 400
	7.0	23'0"	68.45	16.3	53'6"	12 750	12 750	28 100	12 200	26 800
	8.0	26'3"	64.52	15.9	52'2"	10 650	10 650	23 400	10 200	22 400
	9.0	29'6"	60.45	15.3	50'2"	9 100	9 100	20 000	8 700	19 100
	10.0	32'10"	56.20	14.7	48'3"	7 950	7 950	17 500	7 550	16 600
	12.0	39'4"	46.94	13.0	42'8"	6 250	6 250	13 700	5 950	13 100
	14.0	45'11"	35.91	10.7	35'1"	5 150	5 100	11 200	4 850	10 600
14.8	48'7"	30.56	9.4	30'10"	4 750	4 700	10 300	4 500	9 920	

Continued on next page ➡

Boom length	Working radius		Boom angle	Boom point height		Rated load				
						JIS rating	BS rating		PCSA rating	
m (ft in)	m	ft in	degree	m	ft in	kg	kg	lb	kg	lb
19.0 (62'4")	4.6	15'1"	79.50	20.2	66'3"	23 800	24 150	53 200	23 150	51 000
	5.0	16'5"	78.26	20.1	65'11"	20 500	20 550	45 300	19 700	43 400
	6.0	19'8"	75.15	19.8	65'0"	15 750	15 750	34 700	15 100	33 200
	7.0	23'0"	72.00	19.5	64'0"	12 700	12 700	27 900	12 150	26 700
	8.0	26'3"	68.78	19.1	62'8"	10 600	10 600	23 300	10 150	22 300
	9.0	29'6"	65.49	18.7	61'4"	9 050	9 050	19 900	8 650	19 000
	10.0	32'10"	62.11	18.2	59'9"	7 900	7 900	17 400	7 500	16 500
	12.0	39'4"	54.98	16.9	55'5"	6 200	6 200	13 600	5 900	13 000
	14.0	45'11"	47.14	15.3	50'2"	5 050	5 000	11 000	4 800	10 500
	16.0	52'6"	38.10	13.0	42'8"	4 250	4 200	9 250	4 000	8 810
17.4	57'1"	30.46	10.9	35'9"	3 800	3 700	8 150	3 550	7 820	
22.0 (72'2")	5.1	16'9"	79.60	23.1	75'9"	20 000	20 500	45 100	19 650	43 300
	6.0	19'8"	77.22	22.9	75'2"	15 700	15 700	34 600	15 050	33 100
	7.0	23'0"	74.53	22.6	74'2"	12 650	12 650	27 800	12 100	26 600
	8.0	26'3"	71.80	22.3	73'2"	10 550	10 550	23 200	10 050	22 100
	9.0	29'6"	69.02	22.0	72'2"	9 000	9 000	19 800	8 600	18 900
	10.0	32'10"	66.19	21.5	70'6"	7 800	7 800	17 100	7 450	16 400
	12.0	39'4"	60.33	20.5	67'3"	6 100	6 100	13 400	5 800	12 700
	14.0	45'11"	54.08	19.2	63'0"	5 000	4 900	10 800	4 700	10 300
	16.0	52'6"	47.29	17.5	57'5"	4 150	4 100	9 030	3 950	8 700
	18.0	59'1"	39.62	15.4	50'6"	3 550	3 450	7 600	3 350	7 380
20.0	65'7"	30.38	12.4	40'8"	3 050	2 950	6 500	2 850	6 280	
25.0 (82'0")	6.0	19'8"	78.78	26.0	85'4"	15 650	15 650	34 500	15 000	33 000
	7.0	23'0"	76.43	25.8	84'8"	12 600	12 600	27 700	12 050	26 500
	8.0	26'3"	74.05	25.5	83'8"	10 500	10 500	23 100	10 000	22 000
	9.0	29'6"	71.65	25.2	82'8"	8 950	8 950	19 700	8 500	18 700
	10.0	32'10"	69.20	24.8	81'4"	7 750	7 750	17 000	7 400	16 300
	12.0	39'4"	64.19	23.9	78'5"	6 050	6 000	13 200	5 750	12 600
	14.0	45'11"	58.95	22.8	74'10"	4 900	4 850	10 600	4 650	10 200
	16.0	52'6"	53.39	21.4	70'3"	4 100	4 000	8 810	3 850	8 480
	18.0	59'1"	47.40	19.7	64'8"	3 450	3 350	7 380	3 250	7 160
	20.0	65'7"	40.73	17.6	57'9"	2 950	2 850	6 280	2 800	6 170
22.0	72'2"	32.99	14.9	48'11"	2 600	2 450	5 400	2 400	5 290	
22.6	74'2"	30.33	13.9	45'7"	2 500	2 350	5 180	2 300	5 070	
28.0 (91'10")	6.5	21'4"	79.00	29.0	95'2"	14 000	15 550	34 200	14 900	32 800
	7.0	23'0"	77.91	28.8	94'6"	12 500	12 500	27 500	11 950	26 300
	8.0	26'3"	75.80	28.6	93'10"	10 400	10 400	22 900	9 900	21 800
	9.0	29'6"	73.68	28.3	92'10"	8 850	8 850	19 500	8 450	18 600
	10.0	32'10"	71.53	28.0	91'10"	7 650	7 650	16 800	7 300	16 000
	12.0	39'4"	67.14	27.2	89'3"	5 950	5 900	13 000	5 650	12 400
	14.0	45'11"	62.60	26.3	86'3"	4 800	4 750	10 400	4 550	10 000
	16.0	52'6"	57.86	25.1	82'4"	4 000	3 900	8 590	3 750	8 260
	18.0	59'1"	52.85	23.7	77'9"	3 350	3 250	7 160	3 150	6 940
	20.0	65'7"	47.48	22.0	72'2"	2 850	2 750	6 060	2 700	5 950
	22.0	72'2"	41.59	19.9	65'4"	2 500	2 350	5 180	2 300	5 070
	24.0	78'9"	34.91	17.3	56'9"	2 150	2 000	4 400	2 000	4 400
25.2	82'8"	30.28	15.4	50'6"	2 000	1 850	4 070	1 850	4 070	
31.0 (101'9")	7.0	23'0"	79.10	31.9	104'8"	12 450	12 450	27 400	11 900	26 200
	8.0	26'3"	77.20	31.7	104'0"	10 350	10 350	22 800	9 900	21 800
	9.0	29'6"	75.30	31.4	103'0"	8 800	8 800	19 400	8 400	18 500
	10.0	32'10"	73.37	31.1	102'0"	7 600	7 600	16 700	7 250	15 900
	12.0	39'4"	69.46	30.5	100'1"	5 900	5 850	12 800	5 600	12 300
	14.0	45'11"	65.45	29.6	97'1"	4 750	4 700	10 300	4 500	9 920
	16.0	52'6"	61.29	28.6	93'10"	3 950	3 800	8 370	3 700	8 150
	18.0	59'1"	56.97	27.4	89'11"	3 300	3 200	7 050	3 100	6 830
	20.0	65'7"	52.41	25.9	85'0"	2 800	2 700	5 950	2 650	5 840
	22.0	72'2"	47.55	24.2	79'5"	2 400	2 250	4 960	2 250	4 960
	24.0	78'9"	42.27	22.2	72'10"	2 100	1 950	4 290	1 950	4 290
	26.0	85'4"	36.38	19.7	64'8"	1 850	1 650	3 630	1 700	3 740
27.8	91'3"	30.25	16.9	55'5"	1 650	1 450	3 190	1 500	3 300	

Continued on next page ➡

Boom length	Working radius		Boom angle	Boom point height		Rated load				
						JIS rating	BS rating		PCSA rating	
m (ft in)	m	ft in	degree	m	ft in	kg	kg	lb	kg	lb
34.0 (111'7")	8.0	26'3"	78.35	34.8	114'2"	10 250	10 250	22 500	9 800	21 600
	9.0	29'6"	76.62	34.5	113'2"	8 700	8 700	19 100	8 300	18 200
	10.0	32'10"	74.88	34.3	112'6"	7 500	7 500	16 500	7 150	15 700
	12.0	39'4"	71.35	33.6	110'3"	5 850	5 750	12 600	5 550	12 200
	14.0	45'11"	67.74	32.9	107'11"	4 650	4 550	10 000	4 400	9 700
	16.0	52'6"	64.04	32.0	105'0"	3 850	3 700	8 150	3 600	7 930
	18.0	59'1"	60.21	30.9	101'5"	3 200	3 050	6 720	3 000	6 610
	20.0	65'7"	56.23	29.6	97'1"	2 700	2 550	5 620	2 550	5 620
	22.0	72'2"	52.05	28.2	92'6"	2 300	2 150	4 730	2 150	4 730
	24.0	78'9"	47.61	26.5	86'11"	2 000	1 850	4 070	1 850	4 070
	26.0	85'4"	42.82	24.4	80'1"	1 750	1 550	3 410	1 600	3 520
	28.0	91'10"	37.56	22.0	72'2"	1 500	1 350	2 970	1 400	3 080
30.0	98'5"	31.55	19.1	62'8"	1 300	1 150	2 530	1 200	2 640	
30.5	100'1"	30.00	18.4	60'4"	1 200	1 050	2 310	1 100	2 420	
37.0 (121'5")	8.0	26'3"	79.31	37.8	124'0"	10 250	10 250	22 500	9 800	21 600
	9.0	29'6"	77.73	37.6	123'4"	8 700	8 700	19 100	8 300	18 200
	10.0	32'10"	76.13	37.4	122'9"	7 500	7 450	16 400	7 150	15 700
	12.0	39'4"	72.91	36.8	120'9"	5 800	5 700	12 500	5 500	12 100
	14.0	45'11"	69.64	36.1	118'5"	4 650	4 550	10 000	4 400	9 700
	16.0	52'6"	66.29	35.3	115'10"	3 800	3 650	8 040	3 600	7 930
	18.0	59'1"	62.85	34.3	112'6"	3 150	3 050	6 720	3 000	6 610
	20.0	65'7"	59.29	33.2	108'11"	2 700	2 500	5 510	2 500	5 510
	22.0	72'2"	55.60	31.9	104'8"	2 300	2 100	4 620	2 100	4 620
	24.0	78'9"	51.74	30.4	99'9"	1 950	1 800	3 960	1 800	3 960
	26.0	85'4"	47.66	28.7	94'2"	1 700	1 500	3 300	1 550	3 410
	28.0	91'10"	43.28	26.7	87'7"	1 450	1 250	2 750	1 350	2 970
30.0	98'5"	38.51	24.4	80'1"	1 200	1 050	2 310	1 150	2 530	
32.0	105'0"	33.18	21.6	70'10"	1 000	900	1 980	1 000	2 200	
40.0 (131'3")	9.0	29'6"	78.66	40.7	133'6"	8 600	8 600	18 900	8 200	18 000
	10.0	32'10"	77.19	40.5	132'11"	7 400	7 350	16 200	7 050	15 500
	12.0	39'4"	74.23	39.9	130'11"	5 700	5 600	12 300	5 400	11 900
	14.0	45'11"	71.23	39.3	128'11"	4 550	4 450	9 810	4 300	9 470
	16.0	52'6"	68.17	38.6	126'8"	3 700	3 550	7 820	3 500	7 710
	18.0	59'1"	65.04	37.7	123'8"	3 100	2 900	6 390	2 900	6 390
	20.0	65'7"	61.82	36.7	120'5"	2 600	2 400	5 290	2 400	5 290
	22.0	72'2"	58.51	35.5	116'6"	2 200	2 000	4 400	2 050	4 510
	24.0	78'9"	55.07	34.2	112'3"	1 850	1 650	3 630	1 700	3 740
	26.0	85'4"	51.48	32.7	107'3"	1 550	1 400	3 080	1 450	3 190
	28.0	91'10"	47.70	30.9	101'5"	1 300	1 150	2 530	1 250	2 750
	30.0	98'5"	43.67	29.0	95'2"	1 100	950	2 090	1 050	2 310
32.0	105'0"	39.31	26.7	87'7"	900	800	1 760	900	1 980	

Rated Load for Main Boom

Notes:

- The rated loads shown are based on the machine on firm level ground without traveling.
- The rated loads shown include the weights of all lifting attachments, such as hook and bucket. The load to be actually lifted is the rated load minus the weight of all lifting attachments.
- When the jib or the auxiliary jib is attached, the load to be actually lifted is the rated load minus the weight listed below.

Jib length	6.10 m (20'0")	9.15 m (30'0")	12.2 m (40'0")	15.25 m (50'0")	Aux. Jib
Weight to be reduced	700 kg (1 540 lb)	850 kg (1 870 lb)	1 000 kg (2 200 lb)	1 150 kg (2 540 lb)	200 kg (440 lb)

- The jib can be attached to boom of 19.0 m (62'4") to 34.0 m (111'7") long.
- The auxiliary jib can be attached to boom of 10.0 m (32'10") to 37.0 m (121'5") long.
- The rated load for auxiliary jib is equal to that of main boom at the same working radius, but do not exceed maximum rated load 5 000 kg (11 000 lb)

- Counterweight is 11 600 kg (25 600 lb).
- In operation, crawlers must be extended.

Rated Load for Jib

Maximum jib rating

Jib length	6.10 m (20'0")	9.15 m (30'0")	12.20 m (40'0")	15.25 m (50'0")
Jib offset angle				
Max. rated load	10°	5 000 kg (11 000 lb)	5 000 kg (11 000 lb)	4 000 kg (8 820 lb)
	30°	5 000 kg (11 000 lb)	5 000 kg (11 000 lb)	3 200 kg (7 050 lb)

Notes:

- The rated load for jib is equal to that of the main boom at the same working radius, but should not exceed maximum jib ratings shown.
The jib offset angle to the main boom is 10° and 30° under load condition.
- The maximum working radius of the jib do not exceed that of the main boom used.

Main Boom & Jib Construction

Main Boom Construction

Boom length		10.0 m (32'10")	13.0 m (42'8")	16.0 m (52'6")	19.0 m (62'4")	22.0 m (72'2")	25.0 m (82'0")	28.0 m (91'10")	31.0 m (101'8")	34.0 m (111'7")	37.0 m (121'5")	40.0 m (131'3")	
Element													
Lower boom	5.5 m (18'1")	1	1	1	1	1	1	1	1	1	1	1	
Upper boom	4.5 m (16'5")	1	1	1	1	1	1	1	1	1	1	1	
Boom insert	3.0m (9'10")	—	1	2	1	2	1	2	1	2	1	2	
Boom insert	6.0 m (19'8")	—	—	—	1	1	2	2	3	3	4	4	
Available hook		35 000 kg (77 200 lb) hook						15 000 kg (33 100 lb) hook					
Number of rope reeving		7	7	6	5	4	3	3	3	2	2	2	
Boom available with jib		X										X	
Boom available with auxiliary jib													

Jib Construction

Jib length		6.10 m (20'0")	9.15 m (30'0")	12.20 m (40'0")	15.25 m (50'0")
Element					
Lower jib	3.05 m (10'0")	1	1	1	1
Upper jib	3.05 m (10'0")	1	1	1	1
Jib insert	3.05m (10'0")	—	1	2	3
Available hook		5 000 kg (11 000 lb) hook			

Auxiliary jib (Optional)

Attachable to main boom top for hoisting lightweight load quickly with a single rope used. (For safety: The not use the main and auxiliary hooks at the same time.)

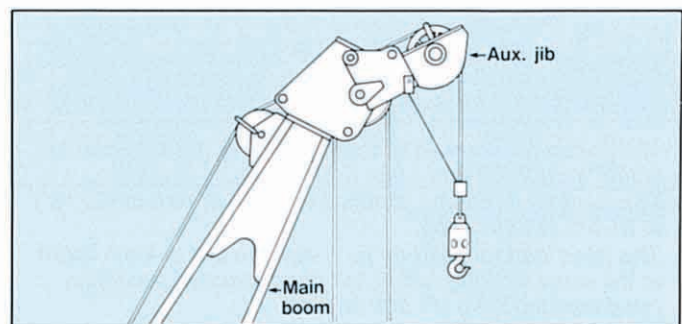



CLAMSHELL

With Tubular CRANE Boom

Dimensions

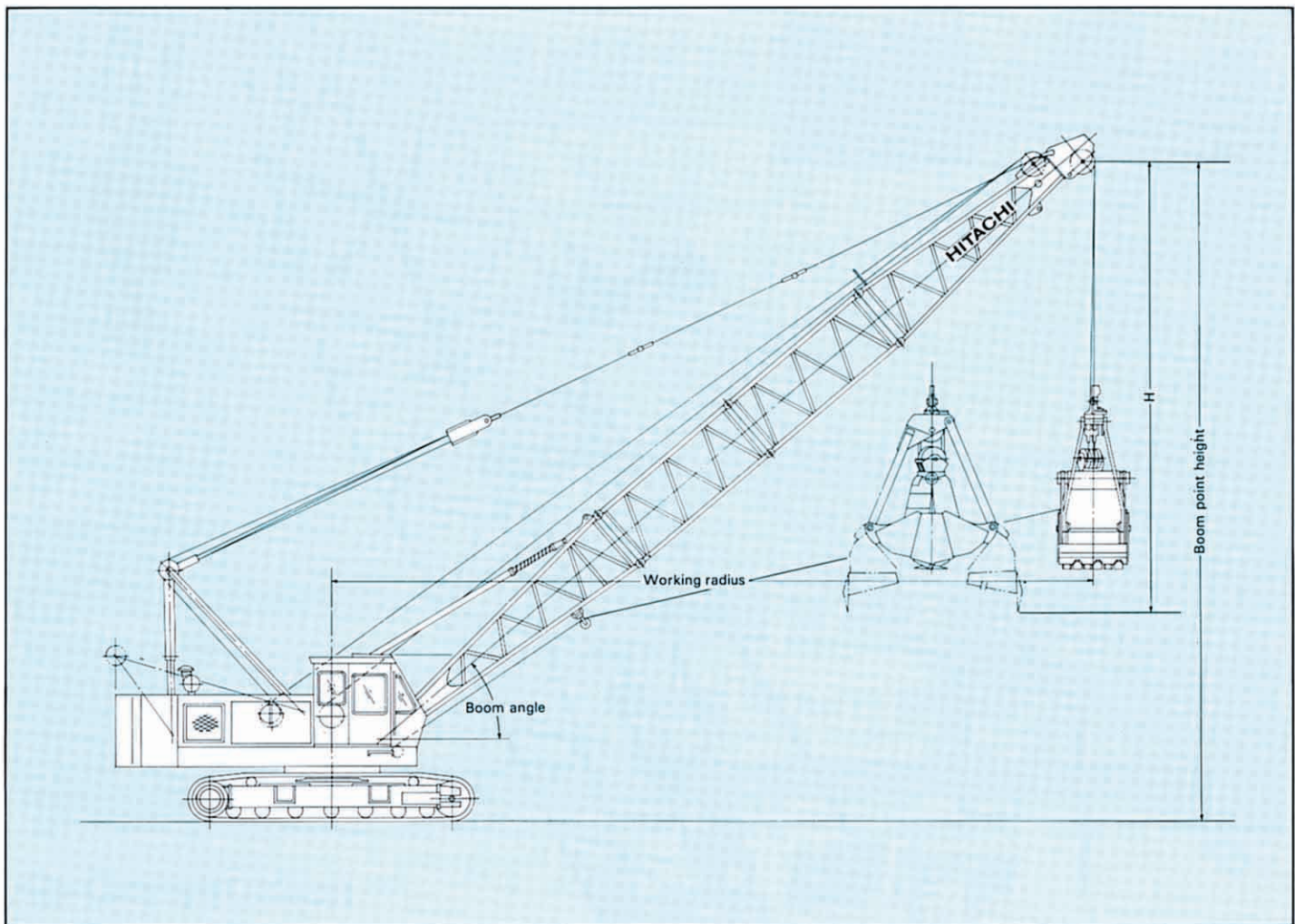

Specifications

Bucket capacity	0.6 m ³ (0.78 cu yd) — 1.2 m ³ (1.57 cu yd)
Boom length	10.0 m (32'10") — 19.0 m (62'4")
* Operating weight	38 850 kg (85 650 lb) when equipped with 10.0 m (32'10") boom, 1.0 m ³ (1.31 cu yd) bucket and 11 600 kg (25 600 lb) counterweight
Ground pressure	0.57 bar (0.57 kgf/cm ² , 8.06 psi)

Notes:

1. For common specifications which are not listed above, refer to p.4 and 5.
2. *Operating weights are approximate.

BUCKETS

Capacity	Self weight	Bucket clearance: H
0.6 m ³ (0.78 cu yd)	1 600 kg (3 530 lb)	5.1 m (16'9")
0.8 m ³ (1.05 cu yd)	2 000 kg (4 410 lb)	5.4 m (17'9")
1.0 m ³ (1.31 cu yd)	2 450 kg (5 400 lb)	5.7 m (18'8")
*1.2 m ³ (1.57 cu yd)	2 400 kg (5 290 lb)	5.7 m (18'8")

* 1.2 m³ (1.57 cu yd) bucket is light-duty service.

TAGLINE

	Maximum digging depth
Hydraulic operated type	36.0 m (118'1")

Clamshell Ratings and Working Ranges

Boom length	Working radius		Boom angle	Boom point height		Rated loads								
						JIS rating	BS rating (1)		BS rating (2)		PCSA rating (1)		PCSA rating (2)	
						kg	kg	lb	kg	lb	kg	lb	kg	lb
m (ft in)	m	ft in	degree	m	ft in	kg	kg	lb	kg	lb	kg	lb	kg	lb
10.0 (32'10")	5.5	18'1"	65	10.6	34'9"	5 000	6 000	13 230	5 000	11 000	6 000	13 230	5 000	11 000
	7.0	23'0"	55	9.7	31'10"	5 000	6 000	13 230	5 000	11 000	6 000	13 230	5 000	11 000
	8.3	27'3"	45	8.6	28'3"	5 000	6 000	13 230	5 000	11 000	6 000	13 230	5 000	11 000
	9.4	30'10"	35	7.2	23'7"	5 000	6 000	13 230	5 000	11 000	6 000	13 230	5 000	11 000
13.0 (42'8")	6.7	22'0"	65	13.3	43'8"	5 000	6 000	13 230	5 000	11 000	6 000	13 230	5 000	11 000
	8.7	28'7"	55	12.2	40'0"	5 000	6 000	13 230	5 000	11 000	6 000	13 230	5 000	11 000
	10.4	34'2"	45	10.7	35'1"	5 000	6 000	13 230	5 000	11 000	6 000	13 230	5 000	11 000
	11.8	38'9"	35	8.9	29'2"	5 000	5 150	11 350	5 000	11 000	5 550	12 240	5 000	11 000
16.0 (52'6")	8.0	26'3"	65	16.0	52'6"	5 000	6 000	13 230	5 000	11 000	6 000	13 230	5 000	11 000
	10.4	34'2"	55	14.6	47'11"	5 000	6 000	13 230	5 000	11 000	6 000	13 230	5 000	11 000
	12.6	41'5"	45	12.8	42'0"	5 000	4 650	10 250	4 650	10 250	5 000	11 000	5 000	11 000
	14.3	46'11"	35	10.6	34'9"	4 500	3 950	8 710	3 950	8 710	4 250	9 370	4 250	9 370
19.0 (62'4")	9.3	30'6"	65	18.8	61'8"	5 000	6 000	13 230	5 000	11 000	6 000	13 230	5 000	11 000
	12.2	40'1"	55	17.1	56'1"	5 000	4 850	10 690	4 850	10 690	5 150	11 350	5 000	11 000
	14.7	48'3"	45	14.9	48'11"	4 200	3 700	8 160	3 700	8 160	4 000	8 820	4 000	8 820
	16.8	55'2"	35	12.4	40'8"	3 600	3 100	6 830	3 100	6 830	3 350	7 390	3 350	7 390

Notes:

- The rated loads shown include the bucket weight.
The load to be actually lifted is the rated load minus bucket weight.
- The BS (1) and PCSA (1) rated loads shall apply to the power load lowering operation, or free fall operation in the case when buckets self weight are less than 2 500 kg (5 510 lb).
- The BS (2) and PCSA (2) rated loads shall apply to the free fall operation where buckets self weight are over 2 500 kg (5 510 lb).
- In operation, crawlers must be extended.
- Counterweights is 11 600 kg (25 600 lb).
- Permissible boom length for clamshell operation is 10 m (32'10") to 19 m (62'4").
- Length of bucket opening/closing ropes will change according to boom length and excavation depth.
- For bucket power load lowering operation, use a combination of power load lowering and free fall operation with brake half-applied. (Aim for a free fall range within 10 m.)

EARTH DRILL

With Tubular CRANE Boom

Dimensions

Unit: mm (ft in)

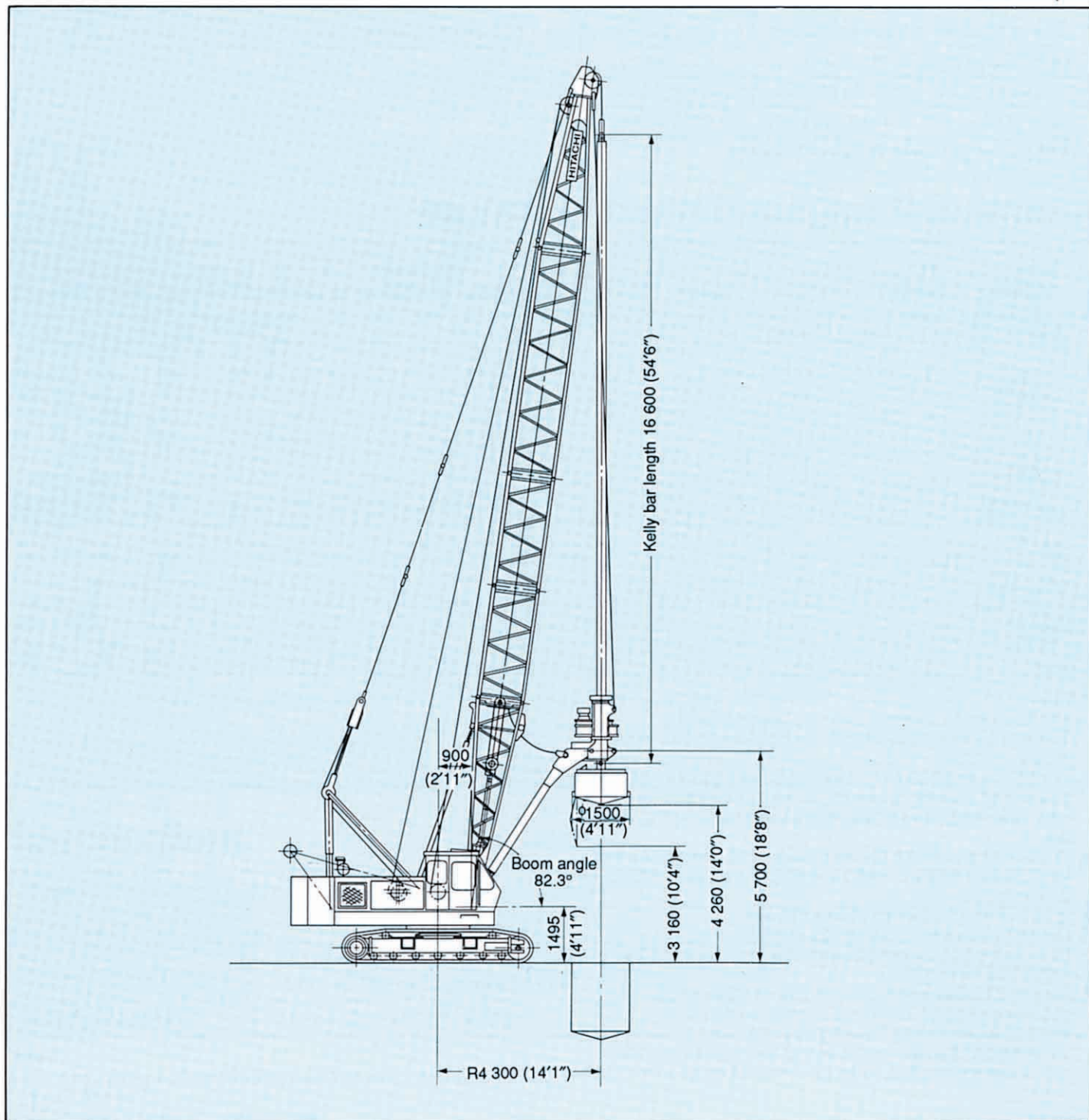

Specifications

Boom length		22.0 m (72'2")
Drilling bore	Common soil	1 500 mm (4'11")
	Loam or soft silt	1 700 mm (5'7") 2 000 mm (6'7") (with reamer knife) *1
Drilling depth	Without stem rod	55 m (180'5")
	With stem rod	65 m (213'3")
Bucket rotation torque		40.2 kN·m (4 100 kgf·m, 29 700 lbf·ft) 49.1 kN·m (5 000 kgf·m, 36 200 lbf·ft), reverse
Bucket hoisting load		123.6 kN (12 600 kgf, 27 800 lbf)
Auxiliary hoisting load *2		4 900 kg (10 800 lb)
Speed	Bucket rotation speed *3	High: 30 min ⁻¹ (30 rpm) Low: 15 min ⁻¹ (15 rpm)
	Bucket hoist (line speed) *3	High: 70 m/min (230 ft/min) Low: 35 m/min (115 ft/min)
	Auxiliary drum hoist (line speed) *3	High: 70 m/min (230 ft/min) Low: 35 m/min (115 ft/min)
	Boom hoist (line speed) *3	60 m/min (197 ft/min)
	Swing	0 — 4.0 min ⁻¹ (0 — 4.0 rpm)
	Travel *3	0 — 1.8 km/h (0 — 1.12 mph)
Counterweight		11 600 kg (25 600 lb)
Operating weight		Approx. 47 000 kg (103 600 lb)
Ground pressure		0.68 bar (0.68 kgf/cm ² , 9.67 psi)

Notes:

*1. The reamer knife should be used for drilling an enlarged hole to insert a stand pipe.

*2. Auxiliary hoisting load varies according to boom angle.
*3. Bucket rotation and line speeds may vary with load.

Drilling Bucket

Bucket D1 mm (ft in)	Side cutter D2 mm (ft in)	Reamer knife D3 mm (ft in)	Height H mm (ft in)	Capacity m ³ (cu yd)	Self weight kg (lb)	Remarks
1 580 (5'2")	1 700 (5'7")	2 000 (6'7")	450 (1'6")	0.86 (1-1/8 cu yd)	1 100 (2 420)	Light duty service
1 480 (4'10")	1 600 (5'3")	1 900 (6'3")	500 (1'8")	0.83 (1 cu yd)	930 (2 050)	Light duty service
1 380 (4'6")	1 500 (4'11")	1 800 (5'11")	650 (2'2")	0.94 (1-1/4 cu yd)	900 (1 980)	
1 280 (4'2")	1 400 (4'7")	1 700 (5'7")	700 (2'4")	0.87 (1-1/8 cu yd)	830 (1 830)	
1 180 (3'11")	1 300 (4'3")	1 600 (5'3")	750 (2'6")	0.8 (1 cu yd)	770 (1 690)	
1 080 (3'7")	1 200 (3'11")	1 500 (4'11")	900 (2'11")	0.8 (1 cu yd)	730 (1 610)	
980 (3'3")	1 100 (3'7")	1 400 (4'7")	900 (2'11")	0.57 (3/4 cu yd)	655 (1 440)	
880 (2'11")	1 000 (3'3")	1 300 (4'3")	900 (2'11")	0.54 (11/16 cu yd)	490 (1 080)	

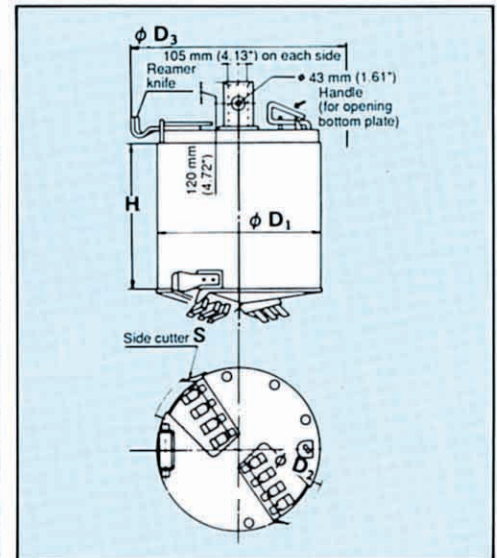

BOOM-SUPPORT TYPE

With Tubular CRANE Boom

Dimensions

Unit: mm (ft in)

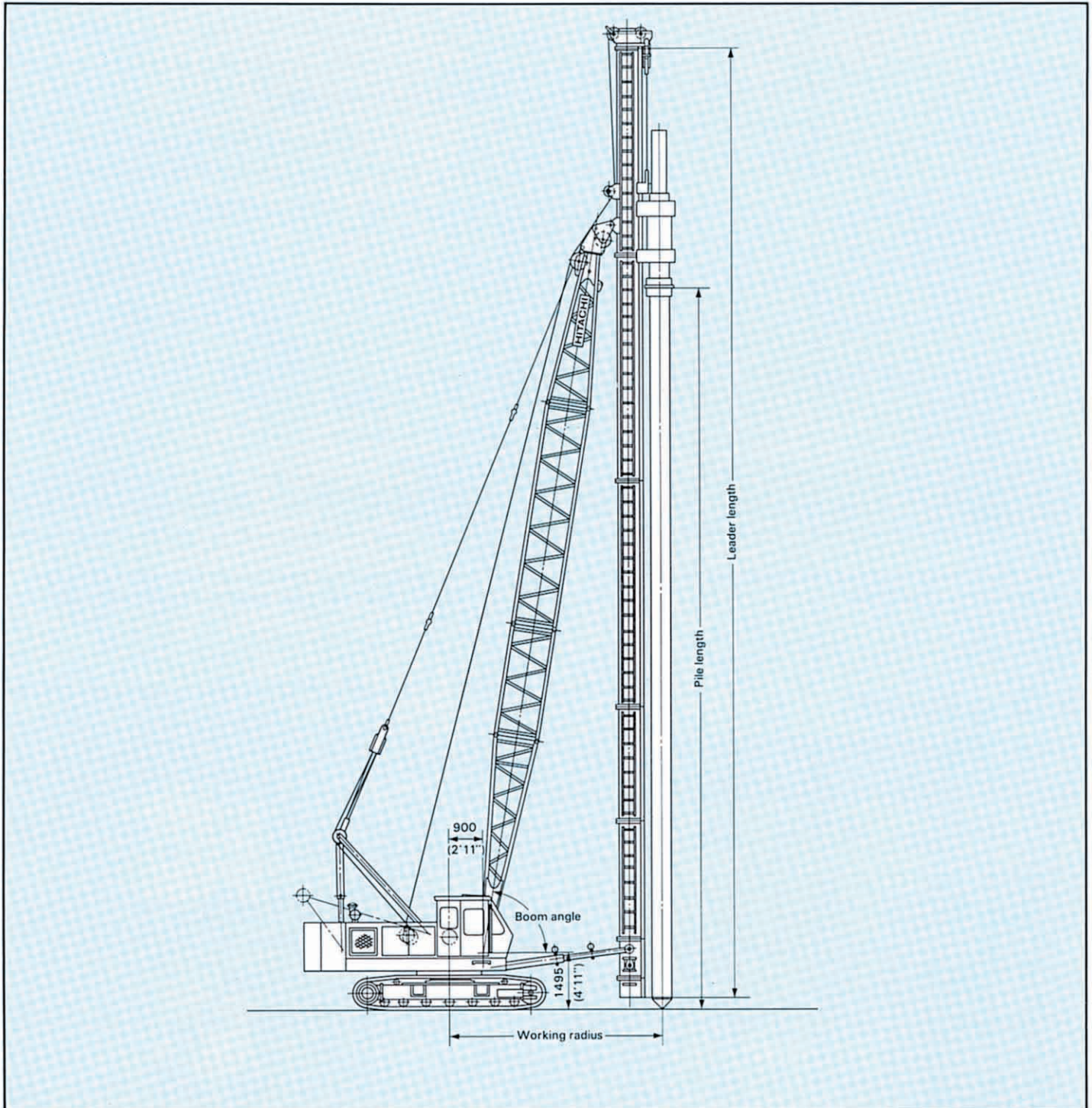

PILE DRIVER

Specifications

Leader		45S																	
Counterweight		kg (lb)																	
		11 600 (25 600)																	
Hammer		25						35						45					
Hammer weight		kg (lb)						kg (lb)						kg (lb)					
Cap weight		kg (lb)						kg (lb)						kg (lb)					
Boom length		m (ft in)		m (ft in)		m (ft in)		m (ft in)		m (ft in)		m (ft in)		m (ft in)		m (ft in)		m (ft in)	
Leader length		m (ft in)		m (ft in)		m (ft in)		m (ft in)		m (ft in)		m (ft in)		m (ft in)		m (ft in)		m (ft in)	
Allowable pile length		m (ft in)		m (ft in)		m (ft in)		m (ft in)		m (ft in)		m (ft in)		m (ft in)		m (ft in)		m (ft in)	
		R		W		R		W		R		W		R		W		R	
Boom angle (degree)	82	4.0 (13'2")	5.0 (11.0)	4.4 (14'5")	5.0 (11.0)	4.8 (15'8")	5.0 (11.0)	5.3 (17'5")	5.0 (11.0)	4.0 (13'2")	7.0 (15.4)	4.5 (14'9")	7.0 (15.4)	4.9 (16'1")	4.6 (10.1)	4.1 (13'5")	9.0 (19.8)	4.5 (14'9")	5.0 (11.0)
	81	4.2 (13'9")	5.0 (11.0)	4.7 (15'7")	5.0 (11.0)	5.1 (16'9")	5.0 (11.0)	5.6 (18'4")	3.8 (8.4)	4.2 (13'9")	7.0 (15.4)	4.7 (15'5")	7.0 (15.4)	5.1 (16'9")	3.2 (7.0)	4.3 (14'1")	9.0 (19.8)	4.8 (15'9")	3.4 (7.5)
	80	4.4 (14'5")	5.0 (11.0)	4.9 (16'9")	5.0 (11.0)	5.4 (17'9")	5.0 (11.0)			4.4 (14'5")	7.0 (15.4)	4.9 (16'1")	6.3 (13.9)	5.4 (17'9")	2.0 (4.4)	4.5 (14'9")	7.9 (17.4)	5.0 (16'5")	2.1 (4.6)
	79	4.5 (14'9")	5.0 (11.0)	5.1 (16'9")	5.0 (11.0)	5.7 (18'8")	4.9 (10.8)			4.6 (15'1")	7.0 (15.4)	5.1 (16'9")	5.0 (11.0)			4.7 (15'5")	6.5 (14.3)		
	78	4.7 (15'5")	5.0 (11.0)	5.3 (17'5")	5.0 (11.0)					4.7 (15'5")	7.0 (15.4)	5.4 (17'9")	3.9 (8.6)			4.8 (15'9")	5.3 (11.7)		
	77	4.9 (16'1")	5.0 (11.0)	5.6 (18'4")	5.0 (11.0)					4.9 (16'1")	7.0 (15.4)	5.6 (18'4")	2.9 (6.4)			5.0 (16'5")	4.1 (9.0)		
	76	5.1 (16'9")	5.0 (11.0)	5.8 (19'1")	5.0 (11.0)					5.1 (16'9")	7.0 (15.4)					5.2 (17'1")	3.1 (6.8)		
	75	5.2 (17'1")	5.0 (11.0)							5.3 (17'5")	6.2 (13.7)					5.3 (17'5")	2.2 (4.9)		
	74	5.4 (17'9")	5.0 (11.0)							5.4 (17'9")	5.3 (11.7)					5.5 (18'1")	1.3 (2.9)		
	73	5.6 (18'4")	5.0 (11.0)							5.6 (18'4")	4.5 (9.9)								
	72	5.7 (18'8")	5.0 (11.0)							5.8 (19'1")	3.8 (8.4)								
71	5.9 (19'4")	5.0 (11.0)																	
Operating weight (Excluding pile weight)		kg (lb)						kg (lb)						kg (lb)					
		46 700 — 49 100 (103 000 — 108 250)						50 200 — 51 800 (110 670 — 114 200)						53 700 — 54 500 (118 400 — 120 150)					
Ground pressure		bar (kg/cm ² , psi)						bar (kg/cm ² , psi)						bar (kg/cm ² , psi)					
		0.68 — 0.71 (0.68 — 0.71, 9.65 — 10.15)						0.73 — 0.75 (0.73 — 0.75, 10.38 — 10.70)						0.78 — 0.79 (0.78 — 0.79, 11.10 — 11.27)					

Note: R Working radius: m (ft in.)
W Pile weight: 1 000 x kg (1 000 x lb)

DRAGLINE

With Angle Chord Boom

Dimensions

Unit: mm (ft in)

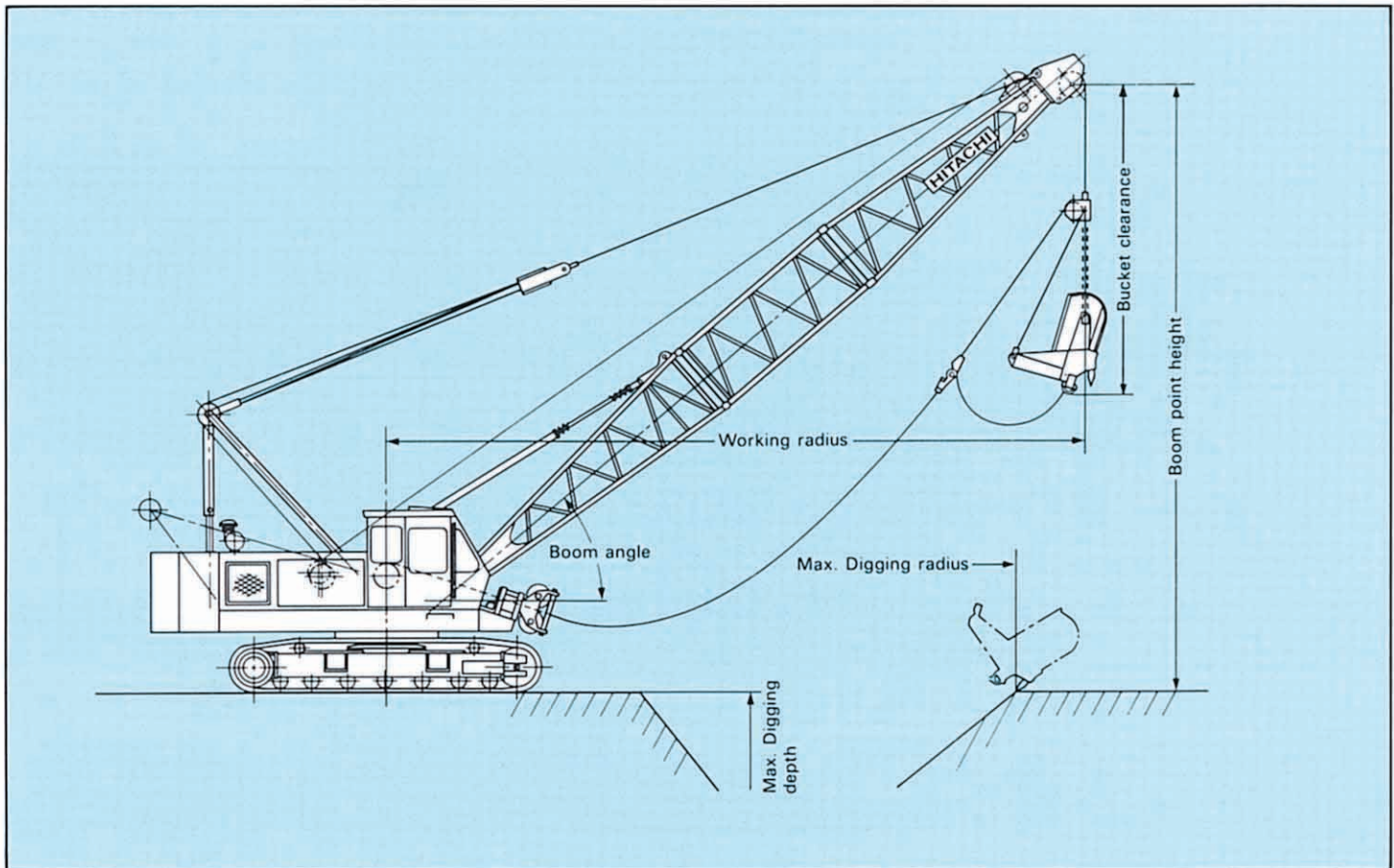

Specifications

Bucket capacity	0.8 m ³ (1.05 cu yd) — 1.0 m ³ (1.31 cu yd)
Boom length	10.0 m (32'10") — 19.0 m (62'4")
Operating weight with 10 m (32'10") boom	Approx. 39 100 kg (86 000 lb) with 1.0 m ³ (1.31 cu yd) bucket
Ground pressure	0.57 bar (0.57 kgf/cm ² , 8.11 psi)

Buckets

Capacity	Self weight	Application	Bucket clearance: H
0.8 m ³ (1.05 cu yd)	1 200 kg (2 700 lb)	Heavy-duty	4.0 m (13'2")
1.0 m ³ (1.31 cu yd)	1 600 kg (3 500 lb)	Medium-duty	4.2 m (13'9")

Dragline Ratings and Working Ranges

Boom length	Working radius		Boom angle	Boom point height		Max. digging reach		Max. digging depth		Rated loads				
										JIS rating	BS rating		PCSA rating	
m (ft in)	m	ft in	degree	m	ft in	m	ft in	m	ft in	kg	kg	lb	kg	lb
10.0 (32'10")	7.7	25'3"	50	9.2	30'0"	11.8	38'9"	5.9	19'4"	3 300	3 300	7 280	3 300	7 280
	8.9	29'3"	40	7.9	25'10"	12.5	41'0"	6.4	20'12"	3 300	3 300	7 280	3 300	7 280
	9.9	32'5"	30	6.4	21'1"	12.8	42'0"	6.7	21'12"	3 300	3 300	7 280	3 300	7 280
13.0 (42'8")	9.6	31'6"	50	11.4	37'5"	14.7	48'3"	8.1	26'6"	3 300	3 300	7 280	3 300	7 280
	11.3	37'1"	40	9.8	32'2"	15.7	51'6"	8.8	29'0"	3 300	3 300	7 280	3 300	7 280
	12.5	41'0"	30	7.9	26'0"	16.1	52'10"	9.1	29'11"	3 300	3 300	7 280	3 300	7 280
16.0 (52'6")	11.6	38'1"	50	13.7	44'11"	17.8	58'5"	10.4	34'1"	3 300	3 300	7 280	3 300	7 280
	13.5	44'3"	40	11.7	38'5"	18.8	61'8"	11.2	36'9"	3 300	3 300	7 280	3 300	7 280
	15.1	49'6"	30	9.4	30'11"	19.3	63'4"	11.5	37'9"	3 300	3 300	7 280	3 300	7 280
19.0 (62'4")	13.5	44'3"	50	16.0	52'6"	20.7	67'11"	12.6	41'4"	3 300	3 300	7 280	3 300	7 280
	15.8	51'10"	40	13.7	44'11"	21.2	69'7"	13.0	42'8"	3 300	3 300	7 280	3 300	7 280
	17.7	58'1"	30	10.9	35'9"	22.6	74'2"	14.0	45'11"	3 200	3 300	7 280	3 300	7 280

Notes:

- The rated loads shown include the bucket weight. The load to be actually lifted is the rated load minus bucket weight.
- Maximum digging reach/depth may vary considerably depending on digging condition and the skill of the operator.
- In operation, crawlers must be extended.
- Counterweight is 11 600 kg (25 570 lb).
- Permissible boom length for dragline operation is 10 m (32'10") to 19 m (62'4").
- Max. digging reach and max. digging depth will change according to operating conditions.

DRUMS

Dimensions

	Rope dia.	Width	Drum p.c.d.	Max. rope capacity
Main hoist drum	22 mm (0.866")	360 mm (14.2")	462 mm (18.19")	224 m (734'11")
Aux. hoist drum	22 mm (0.866")	313 mm (12.3")	462 mm (18.19")	134 m (439'8")

Line speed and line pull

H : High speed range L : Low speed range

	Max. line speed m/min (ft/min)				Effective line pull	@	Line speed	Max. starting line pull	Max. running line pull
	Hoisting		Lowering						
Main hoist drum	H	70 (230)	H	70 (230)	108 kN (11 000 kgf, 24 300 lbf)	@	34 m/min (116 ft/min)	137 kN (14 000 kgf, 30 900 lbf)	143 kN (14 600 kgf, 32 000 lbf)
	L	35 (115)	L	35 (115)					
Aux. hoist drum	H	70 (230)	H	70 (230)	108 kN (11 000 kgf, 24 300 lbf)	@	34 m/min (116 ft/min)	137 kN (14 000 kgf, 30 900 lbf)	143 kN (14 600 kgf, 32 000 lbf)
	L	35 (115)	L	35 (115)					

Notes:

- Line speed and line pull are based on first layer of winding at rated engine rpm.
- Hoisting line speed varies with load.
- Line pull is based on a single line pull in high speed range.
- Effective line pull is equivalent to available line pull of mechanical drive winch.
- When starting, hydraulic motor is without rotating, the line pull is "Max. starting line pull". After motor rotating, the line pull becomes "Max. running line pull" shortly.
- The main and aux. hoist drum ropes run in spiral grooves.

BOOM HOIST DRUM

Rope diameter	Hoisting line speed	Lowering line speed
14 mm (0.551")	60 m/min (197 ft/min)	60 m/min (197 ft/min)

Specifications



SUPERSTRUCTURE



Engine

Model	HINO H06C-T
Type	Water-cooled, 4-cycle, 6-cylinder, direct fuel injection type diesel engine
Rated horsepower (DIN 6 270, Net)	110 kW (150 PS) at 2 000 min ⁻¹ (2 000 rpm)
Maximum torque	530 N·m (54 kgf·m, 391 lbf·ft) at 1 800 min ⁻¹ (1 800 rpm)
Piston displacement	6.845 l (418 cu in)
Fuel tank capacity	250 l (55 imp gal, 66 US gal)
Electric system	24 V DC



Main and Auxiliary Hoist Mechanism

Both main and auxiliary hoist drums are driven by axial piston motors through reduction gear. Load hoisting/lowering are done by normal/reverse rotation of motor. Smooth, precise power lowering is made possible by the hydraulic brake. A single lever gives a choice of two speeds, high or low, for hoisting/lowering. Hoist/lower speeds are proportioned to the lever stroke, allowing easy matching to job conditions.

Clutches Clutches are of the spring-set, hydraulic-released internal-expanding friction band type; main and auxiliary clutches are alike in size and type, with interchangeable clutch linings.

Brakes External contracting friction band-type mechanical brakes, integrated with link lever. Mechanical brake locks are equipped as standard. Furthermore, while in neutral position, the hoist lever is doubly secured in position by a hydraulic brake and an automatic brake.

Drums Main and auxiliary hoist drums are of special alloy cast iron. Both hoist drums are mounted on the lifetime-lubricated antifriction ball bearings. Drum pawl locks are provided for integral lock of drums. They are manually controllable from the operator's seat.



Boom Hoist Mechanism

Completely independent operation. Boom hoisting/lowering is done by normal/reverse driving of the axial piston motor. Boom lowering is made by power lowering through the hydraulic system. Instant hoisting/lowering of boom is possible. Both hydraulic brake and springset hydraulic-released multiplate disc type brake offer positive and safe stopping of boom. When boom is hoisted or lowered, brakes are automatically released.

Boom Brakes Spring-set, hydraulic-released multiplate disc type. Brake is automatically actuated when control lever is at neutral position.

Drum Locks Drum pawl lock is manually controlled from operator's seat.



Swing Mechanism

Completely independent operation. Driven by axial piston motor through reduction gear, swing speeds are freely controllable within the 0 to maximum speed with single lever stroke.

Swing Brake A spring-set/hydraulic-released multiplate disc type swing brake can be hydraulically actuated by brake switch on the swing lever.

Swing Lock Manually operated mechanical lock with a rod tip which is engaged in a holder of track frame during transportation.

Swing Circle Single-row shear-type ball bearing-with heat-treated internal gear.



Revolving Frame

All steel welded construction, stress-relieved, precision-machined unit, especially designed for rigidity and strength.

Gantry Lowerable for transportation.

Counterweight Welded structure. Total weight 11 600 kg
(25 600 lb)

Consists of two sections: one: 5 800 kg (12 790 lb)
one: 5 800 kg (12 790 lb)



Boom

Tubular Chord Crane Boom 1 150 mm (45") wide by, 1 150 mm (45") deep at connection, lattice construction, high tensile strength steel tubular chord.

Basic boom	2-piece, total length 10.0 m (32'10") upper section 4.5 m (14'9") and lower section 5.5 m (18'1").
Boom point	Offset boom point, 4 sheaves [420 mm (16.5") p.c.d.] mounted on antifriction bearings on boom peak.
Boom insert (Optional)	3.0 m (9'10") and 6.0 m (19'8") long available with appurtenant pendants.
Connection type	Pin-connected
Boom backstop	Dual-rail, telescopic tubular construction with spring bumper.
Boom hoist bridle	Serves as connection between pendants and boom hoist wire rope reeving, equipped with 6 sheaves [300 mm (12") p.c.d.] for 12-part boom hoist wire rope reeving.

Crane Jib (Optional) 550 mm (22") wide by 480 mm (19") deep at connection, lattice construction, high tensile strength steel tubular chord.

Basic jib	2-piece, total length 6.10 m (20'0"), upper section 3.05 m (10'0"), and lower section 3.05 m (10'0").
Jib point	1 sheave [420 mm (16.5") p.c.d.] mounted on anti-friction bearings on jib peak.
Jib insert	3.05 m (10'0") long available.
Connection type	Pin-connected
Auxiliary jib	Can be attached to the top of main boom for auxiliary hook hoisting operation.

Note:

Boom insert, crane jib, or auxiliary jib can be attached to the basic boom when needed. However, crane jib and auxiliary jib cannot be attached simultaneously to the boom and used.

Angle Chord Boom 935 mm (36.8") wide by, 935 mm (36.8") deep at connection, lattice construction, high tensile strength steel angle chord.

Basic boom	2-piece, total length 10.0 m (32'10") upper section 5 m (16'5") and lower section 5 m (16'5").
Boom point	Offset boom point, 3 sheaves [462 mm (18.2") p.c.d.] mounted on antifriction bearings on boom peak.
Boom insert (Optional)	3.0 m (9'10") and 6.0 m (19'8") long available with appurtenant pendants.
Connection type	Pin-connected
Boom backstop	Dual-rail, telescopic tubular construction with spring bumper.

Boom hoist bridle Serves as connection between pendants and boom hoist wire rope reeving, equipped with 6 sheaves [300 mm (12") p.c.d.] for 12-part boom hoist wire rope reeving.



Operator's Cab

All-weather, well-ventilated, all-round visibility, roomy operator's cab. The completely independent cab is insulated against noise and vibration. Sliding, fold-in front window swings up and stores in roof. Fully adjustable reclining seat.



UNDERCARRIAGE

Travel mechanism Each track is driven by a axial piston motor through reduction gear. This mechanism allows counterrotation of tracks for maximum maneuverability in close quarters. When lever is at neutral position, both hydraulic brake and spring-set/hydraulic-released multiplate disc brake are automatically actuated to effect reliable stopping. Upper and lower rollers, sprockets and idlers are lifetime-lubricated. A hydraulic track adjuster is provided for easy tension adjustment of each track.

Gradeability	22° (40%)
Travel speed	0—1.8 km/h (0—1.12 mph)

Track Frame All-welded, stress relieved, box section construction.

Side Frame Side frames of all-welded construction can be retracted for transportation.

Side Frame Extending/Retracting Device Side frame extending/retracting is done with the cylinder provided inside the track frame. Hydraulic power source for this extending/retracting cylinder is common with that for the left track. All that's required is to operate the switching valve installed inside the track frame and shift the left travel lever. Then, side frame extending/retracting can easily be done in a short time eliminating troublesome piping, etc.

Track Shoes Heat treated alloy steel castings with induction hardened roller path and driving lugs. Shoes are connected by induction-hardened steel pins.

No. of upper rollers (on each side)	2
No. of lower rollers (on each side)	7
No. of track shoes (on each side)	59
Shoe width	760 mm (30")
Ground pressure	0.53 bar (0.53 kgf/cm ² , 7.54 psi)

When equipped with 10.0 m (32'10") boom, 35 000 kg (77 200 lb) capacity hook and 11 600 kg (25 570 lb) counterweights.

HYDRAULIC SYSTEM

2 variable displacement piston pumps + 1 gear pump hydraulic system allows both independent and combined operations of all functions. Variable-displacement piston pumps not only adequately control operating speeds, but also utilize engine horsepower to maximum.

	Pump-1	Pump-2
Type of pump	Variable displacement pump	
Pressure setting	280 bar (280 kgf/cm ² , 3 980 psi)	280 bar (280 kgf/cm ² , 3 980 psi)
Oil flow	200 l/min (44.0 Imp gpm, 52.8 U S gpm)	200 l/min (44.0 Imp gpm, 52.8 U S gpm)

	Pump-3	Pump-4
Type of pump	Gear pump	
Pressure setting	210 bar (210 kgf/cm ² , 2 990 psi)	45 bar (45 kgf/cm ² , 640 psi)
Oil flow	134 l/min (29.5 Imp gpm, 35.4 U S gpm)	32 l/min (7.0 Imp gpm, 8.5 U S gpm)

Main and Auxiliary Hoist Motor Axial piston motor with counterbalance valve.

Boom Hoist Motor Axial piston motor with counterbalance valve.

Swing Motor Axial piston motor with brake valve and spring-set/hydraulic-released multiplate disc brake.

Travel Motor Axial piston motor with brake valve and spring-set/hydraulic-released multiplate disc brake.

Relief and Brake Valves Each hydraulic circuit incorporates large-capacity relief valves to protect circuit from overload or shock load. Counterbalance valves (compensates safe, positive load lowering and prevents accidental load drop when hydraulic power is suddenly reduced) are provided for hoist motor. Brake valves (consisting of relief valve and counterbalance valve) are provided for travel circuit.

Pressure Setting MAIN CIRCUIT

- Main relief valves
 - Hoist (main and aux.) travel and boom280 bar
(280 kgf/cm², 3 980 psi)
 - Swing210 bar
(210 kgf/cm², 2 990 psi)

- Overload relief valves
 - Hoist (main and aux.) circuit287 bar
(287 kgf/cm², 4 080 psi)
 - Boom hoist circuit265 bar (265 kgf/cm², 3 770 psi)
 - Travel circuit325 bar (325 kgf/cm², 4 620 psi)

PILOT CIRCUIT

- Main relief valve45 bar (45 kgf/cm², 640 psi)

Line, Filters High filtration 10 μ full-flow filter element is provided to keep hydraulic oil clean and ensure long-term, trouble-free operation. Pilot filter and suction filter are provided for each circuit.

CONTROLS

Boom, Main and Auxiliary Hoist and Travel Remote controlled hydraulic servo. Working speed can be precisely controlled by changing lever stroke.

Swing Mechanical linkage type.

Fuel Control Two foot throttle pedals and hand throttle controls equipped as standard.

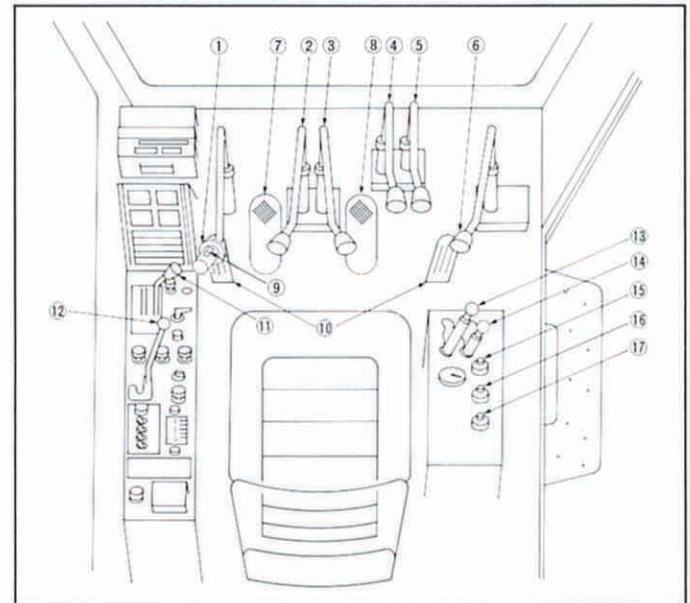

- | | |
|---------------------------------------|-----------------------------|
| 1. Swing lever | 10. Accelerator pedal |
| 2. Aux. hoist lever | 11. Accelerator lever |
| 3. Main hoist lever | 12. Swing lock lever |
| 4. Travel (left) lever | 13. Aux. hoist clutch lever |
| 5. Travel (right) lever | 14. Main hoist clutch lever |
| 6. Boom hoist lever | 15. Main drum lock |
| 7. Aux. drum brake pedal (Pedal lock) | 16. Aux. drum lock |
| 8. Main drum brake pedal (Pedal lock) | 17. Boom drum lock |
| 9. Swing brake switch (Hydraulic) | |

This monitor has the following functions:

- **Instruments:** Machine conditions are shown on meters.
- **Start up inspection monitor:** To check the machine condition and safety device before starting operation.
- **Safety monitor:** To warn the abnormality of the machine during operation and carelessness.

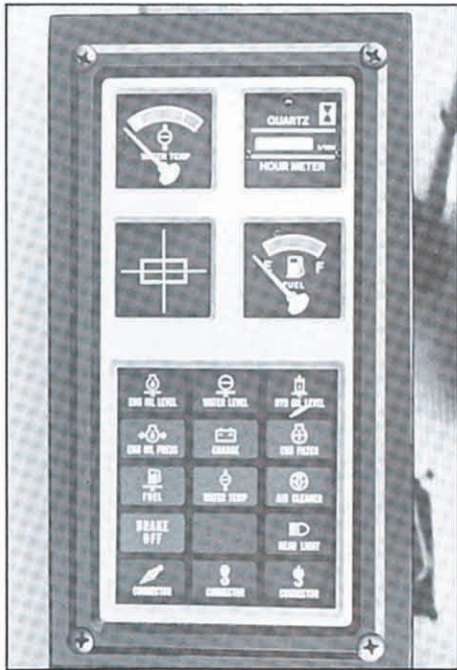

SAFETY DEVICES

Boom Angle Indicator Mechanical type boom angle indicator is provided at boom foot.

Counterbalance Valve (Brake Valve) A Counterbalance valve is incorporated in travel motors, boom hoist motor, main and auxiliary hoist motor respectively. In case the hydraulic line is broken, this valve is automatically actuated to prevent accidents.

Spring-set/Hydraulic-released Multiplate Disc Type Travel Brakes

Swing Lock and Swing Brake

Drum Lock A pawl type drum lock is adopted for main drum, auxiliary drum and boom drum.

Boom Overhoist Prevention Device When the boom reaches its safety angle limit, a buzzer alarm sounds and boom hoisting automatically stops at the same time. A telescope type boom backstop is also installed.

For lift crane

- **Moment Limiter "Hi-Limiter"** The "Hi-Limiter" electrically detects the lifting load, and working radius from the boom angle. The detected data is calculated by a built-in microcomputer. When the lifting load reaches its alarm limit the "Hi-Limiter" buzzes, and when reaching the load limit, the control becomes inoperative.
- **Hook Overhoist Prevention Device** When the hook reaches its safety hoist limit, an alarm bell rings and an auto-stop device automatically stops at the same time.

SERVICE REFILL CAPACITIES

	Liters	Imp gal	US gal
Fuel tank	250.0	55.0	66.0
Engine coolant	26.0	5.7	6.9
Engine oil	20.0	4.4	5.3
Pump transmission	2.7	0.59	0.71
Boom and winch hoist motor reduction device	5.6	1.23	1.48
Winch hoist motor reduction device	13.0	2.86	3.43
Swing reduction device	8.7	1.9	2.3
Travel final device (On each)	9.0	2.0	2.4
Hydraulic system (Including tank capacity)	285.0	62.7	75.2
Hydraulic tank	205.0	45.1	54.1

OPTIONAL EQUIPMENT

Operator's Cab Electric fan, cab cooler.

Third Drum

P.T.O. Driving a generator.

A built-in type lifting magnet or a welder can be installed.

Auxiliary Jib Can be attached to the top of main boom for auxiliary hook-hoisting operation.

Track Shoes 710 mm (28") forged steel tractor type.

KH AND PD SERIES

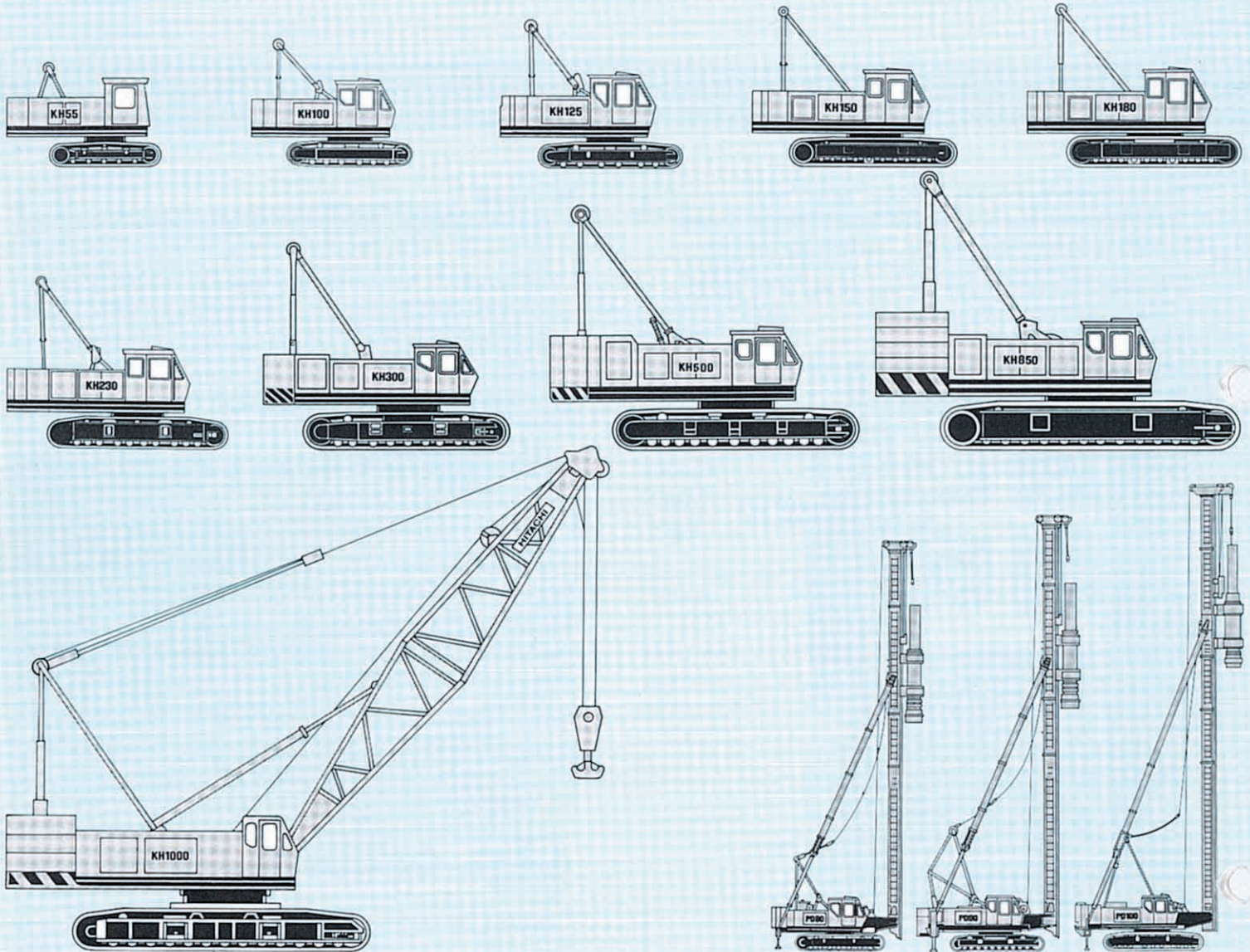

These specifications are subject to change without notice.

Hitachi Construction Machinery Co.,Ltd.

Head Office: Nippon Bldg., 6-2, 2-chome, Ohtemachi,
Chiyoda-ku, Tokyo 100, Japan

Telephone: Tokyo (03) 3245-6361

Facsimile: Tokyo (03) 3246-2606

Telex: J 32539 HITACONJ

Cable Address: "TOKHITACHIKENKI"